

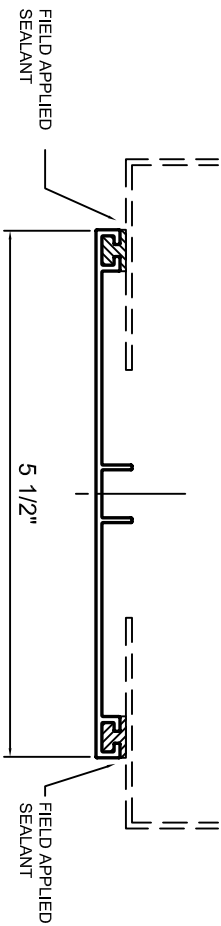

Aluminum Windows

Mon-Ray, Inc.
Phone: (800) 544-3646
Fax: (763) 546-8977
www.monray.com

#1202 FASTEN-ON MULLION COVER



#1400 SLIDE-ON MULLION COVER

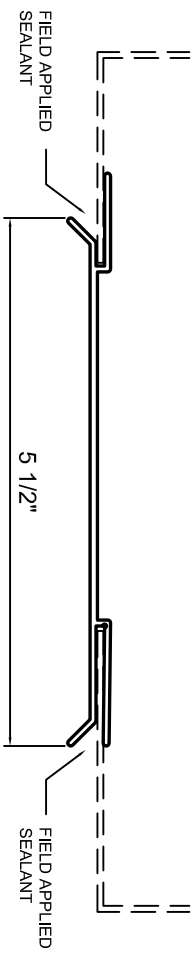

#1611 SLIDE-ON PANNING EXPANDER

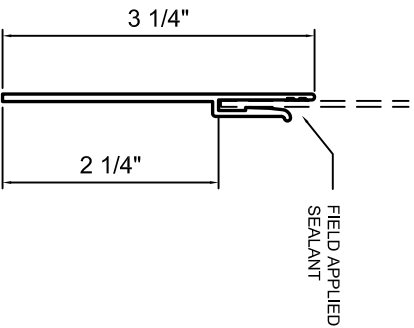

#1510 SLIDE-ON MULLION COVER

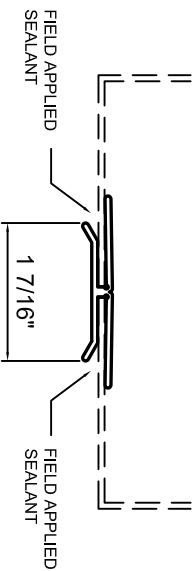

FULL SCALE (11 x 17)

HALF SCALE (8-1/2 x 11)

DeVAC 600 SERIES
MISC. TRIMS

ACCESSORIES
DETAILS

MULL COVERS 1202, 1400, 1510
EXPANDER 1611

DRAWING
DV-600-050